

PTISPEC®

a **DOMAILLE ENGINEERING** solution

PRODUCT LIST

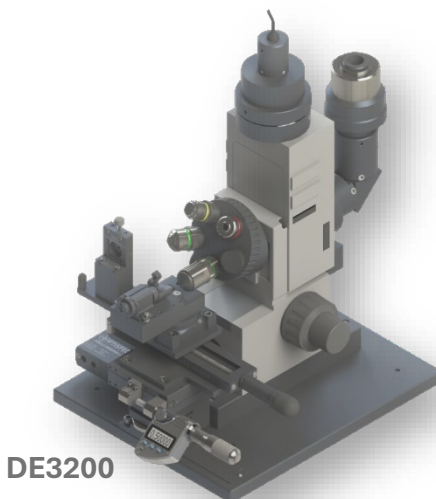
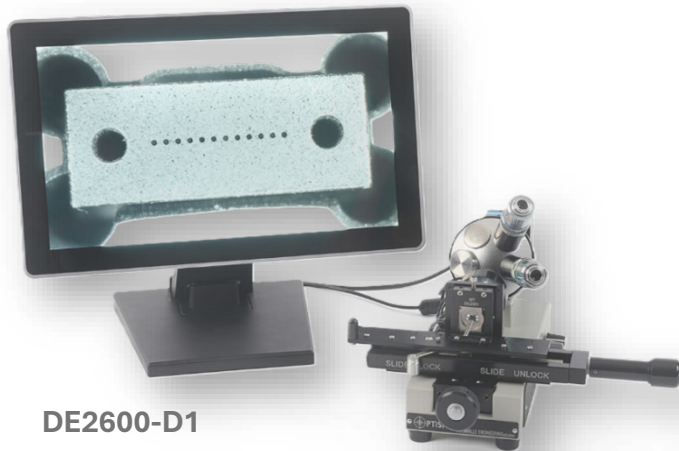

CONTENTS

Microscopes.....	pages 3-4
Adapters.....	pages 5-18
Inserts for DE8800.....	pages 19-21
Monitors.....	pages 22-23
Cables & Power Supplies.....	pages 24-25
Objectives.....	page 26
Cameras.....	page 27
Accessories.....	pages 28-30

Microscopes

Image	Part Number Description
	<p>DE2503 Microscope Assembly, 2503</p>
	<p>DE2503-D1 Microscope Assembly, 2503 Digital Inspection Microscope, Includes Camera and Monitor</p>
	<p>DE2510-C Microscope Assembly, 2510-C, Bare Fiber Inspection Microscope</p>
	<p>DE2510-D Microscope Assembly, 2510-D, Fiber Array Inspection Microscope</p>
	<p>DE2600-D1 Microscope Assembly, 2600 MT Digital Inspection Scope, Oblique Light, Includes Monitor</p>

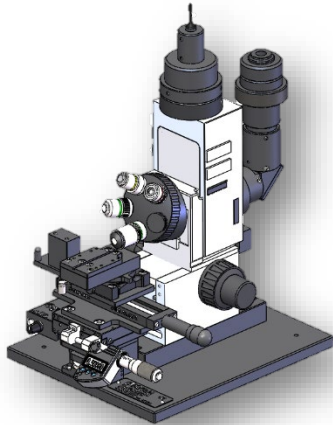

DE3200

Microscope Assembly, 3200, Lab
Microscope

DE3200-S2

Microscope Assembly, 3200-S2,
Bare Fiber +

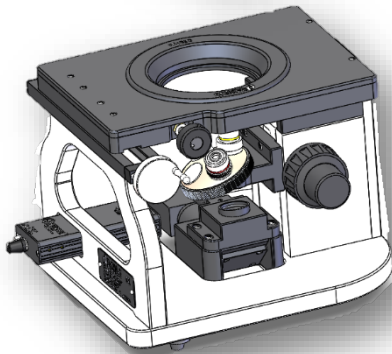

DE8850

Microscope Assembly, 8850
Inverted

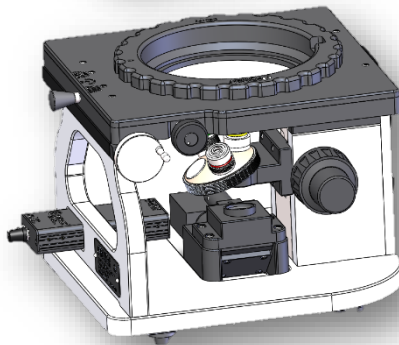

DE8880

Microscope Assembly, 8880
Inverted

Adapters and Inserts sold separately

Adapters

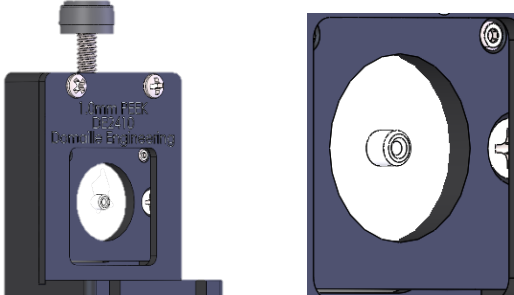
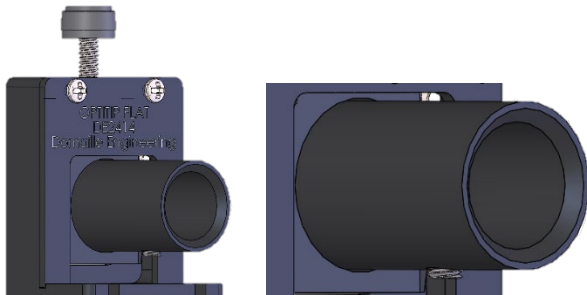
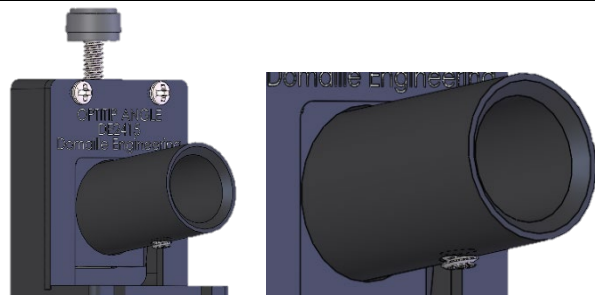
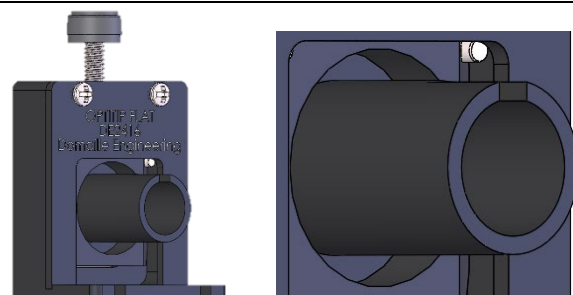
Image	Part Number Description
	<p>DE2410 Adapter, 1.0 MM Peek</p>
	<p>DE2414 Adapter, Optitip Male, Flat Polish</p>
	<p>DE2415 Adapter, Optitip Male, Angle Polish</p>
	<p>DE2416 Adapter, Optitip Female, Flat Polish</p>

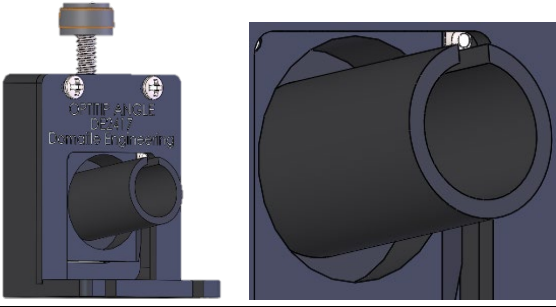
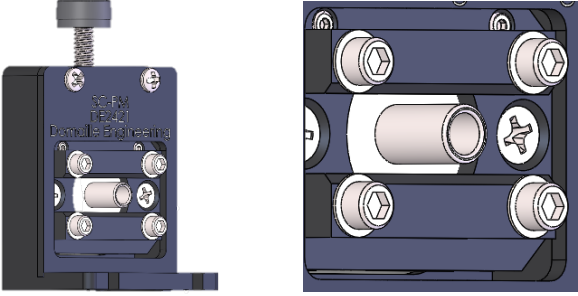
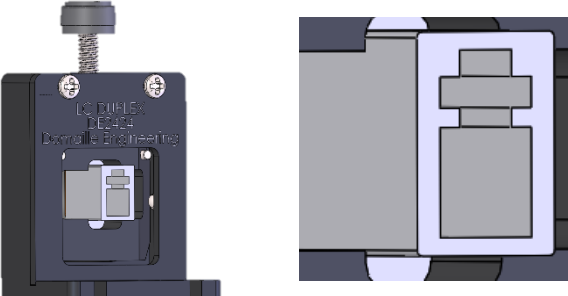
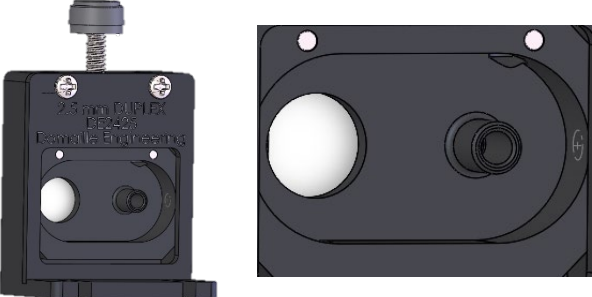
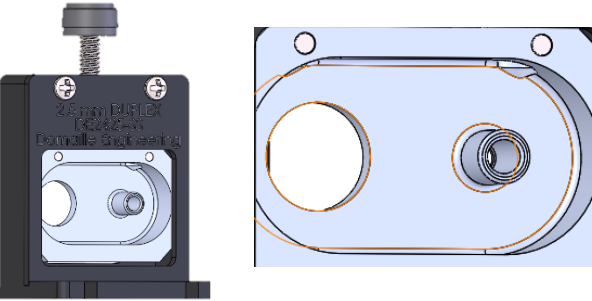
	<p>DE2417 Adapter, Optitip Female, Angle Polish</p>
	<p>DE2421 Adapter, SC PM</p>
	<p>DE2424 Adapter, LC Duplex, Keyed Insert</p>
	<p>DE2425 Adapter, LC Duplex, W/Aperature, Aluminum</p>
	<p>DE2425-SS Adapter, LC Duplex, W/Aperature, Stainless</p>

	<p>DE2433 Adapter, FC Keyed, Carbide Insert for PM</p>
	<p>DE2439 Adapter, 1.6 MM, 29504-4/5 Mil Pin</p>
	<p>DE2446 Adapter, SMC</p>
	<p>DE2447 Adapter, Blank Insert, Aluminum or Delrin</p>
	<p>DE2449 Adapter, OptiTaP Connector</p>

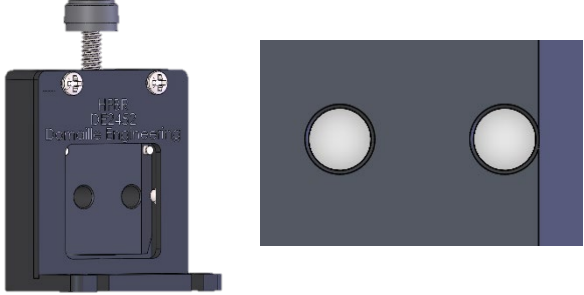
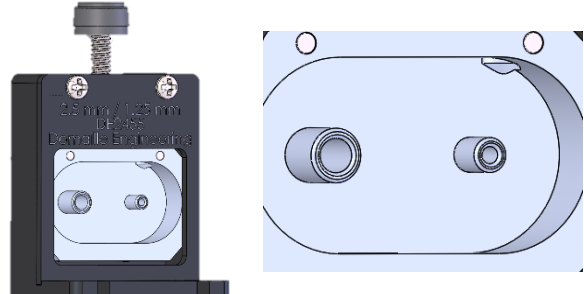
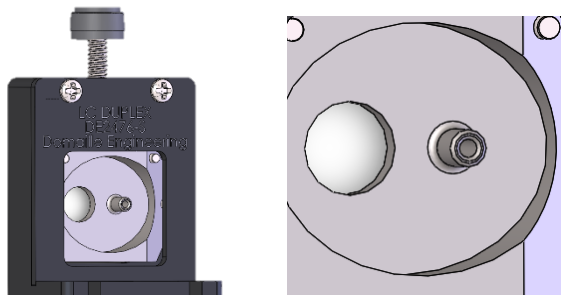
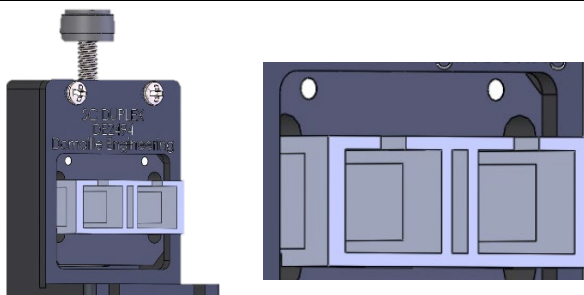
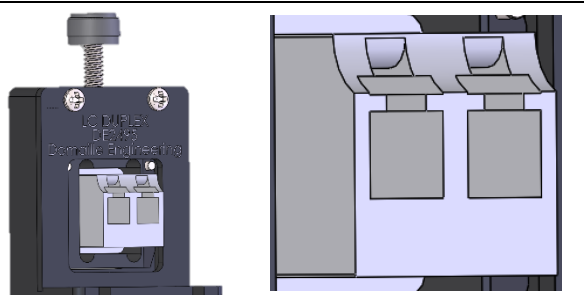
	<p>DE2452 Adapter, HFBR</p>
	<p>DE2455 Adapter, 2.5/1.25mm Combo</p>
	<p>DE2476-S Adapter, LC Duplex w/One Aperture, Stainless</p>
	<p>DE2494 Adapter, SC Keyed Duplex w/Metal Housing</p>
	<p>DE2495 Adapter, LC Duplex Keyed</p>

		<p>DE2496 Adapter, 2.5 MM, Stainless, Through Hole</p>
		<p>DE2497 Adapter, 2.0 MM D-4, Peek Insert</p>
		<p>DE2499 Adapter, 1.25 MM Insert, Hardened Steel</p>
		<p>DE2532 Adapter, New Style MTP, Spring load</p>
		<p>DE2550 Adapter, 1.8 MM</p>

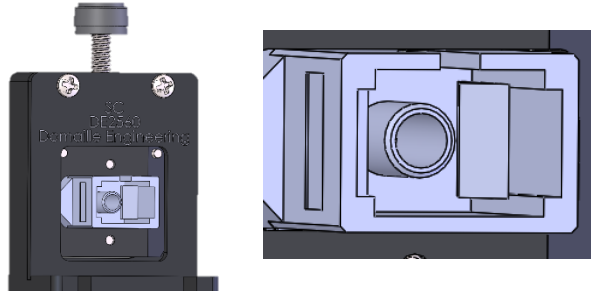
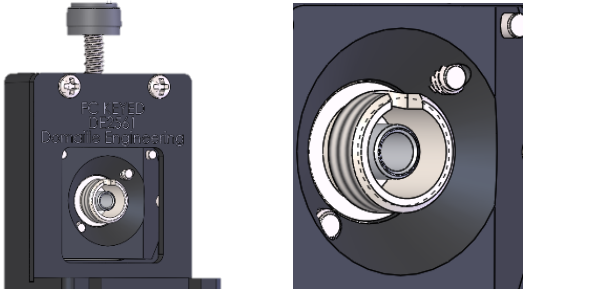
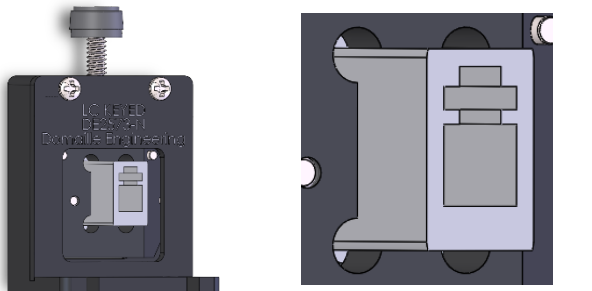
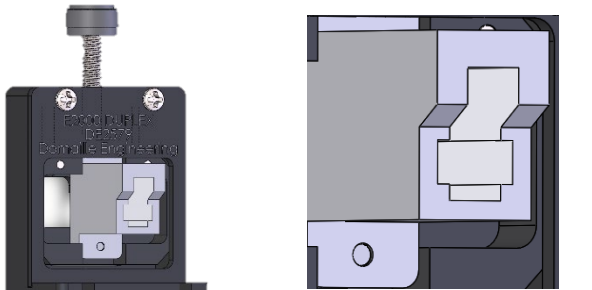
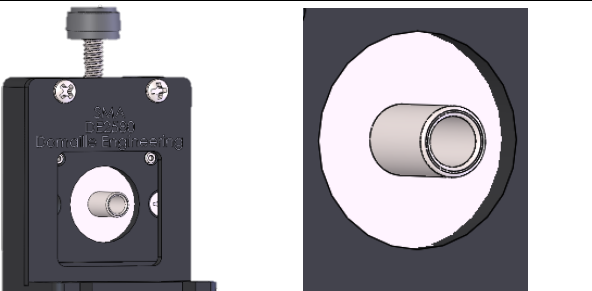



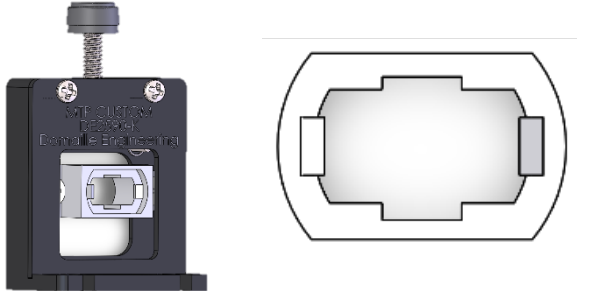
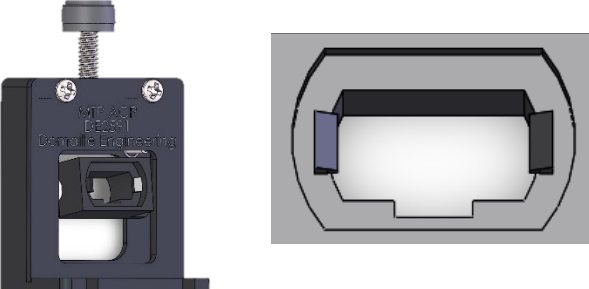
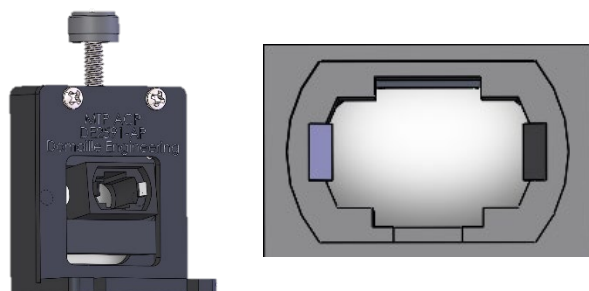
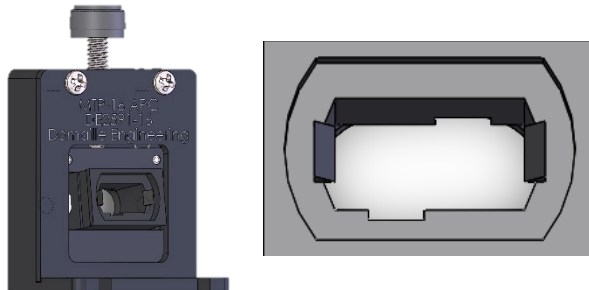
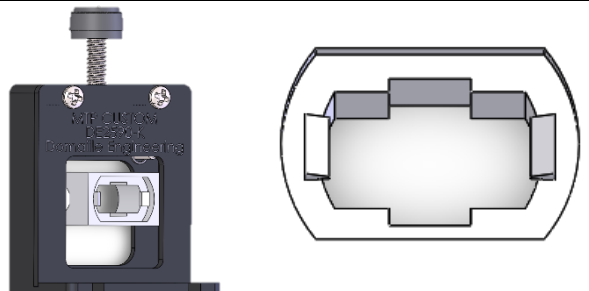

	<p>DE2560 Adapter, SC Keyed</p>
	<p>DE2561 Adapter, FC Keyed, Zirconia Sleeve</p>
	<p>DE2573-N Adapter, LC Keyed, Zirconia Sleeve</p>
	<p>DE2579 Adapter, E2000 Simplex/Duplex Insert</p>
	<p>DE2580 Adapter, SMA Slip Fit for 905</p>

		<p>DE2580-TH Adapter, SMA Threaded for 905/906</p>
		<p>DE2581 Adapter, MT Ferrule</p>
		<p>DE2582 Adapter, MPX, Flat Polish</p>
		<p>DE2583 Adapter, Mini MT ferrule, MTRJ</p>
		<p>DE2584 Adapter, MT-RJ Connector</p>

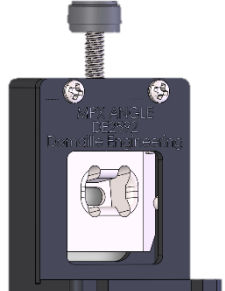
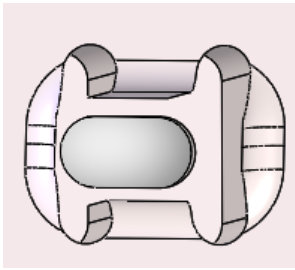
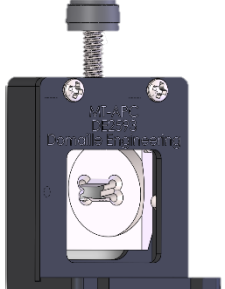
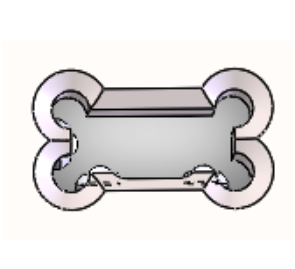
		<p>DE2585 Adapter, 2.5mm, Stainless</p>
		<p>DE2585-2 Adapter, 2.5mm, Peek</p>
		<p>DE2585-A Adapter, 2.5 mm, Stainless, Angle</p>
		<p>DE2586 Adapter, 1.25mm, Peek</p>
		<p>DE2586-2 Adapter, 1.25mm, Stainless</p>

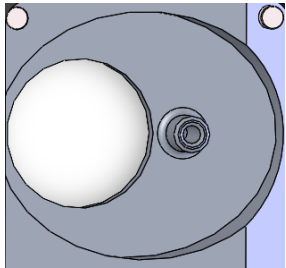
		<p>DE2586-A Adapter, 1.25mm, Peek, APC</p>
		<p>DE2589 Adapter, MDC, APC Connector</p>
		<p>DE2590 Adapter, MTP Mounting Insert</p>
		<p>DE2590-AP Adapter, MTP-All Purpose</p>
		<p>DE2590-16 Adapter, MTP-16 Mounting Insert</p>

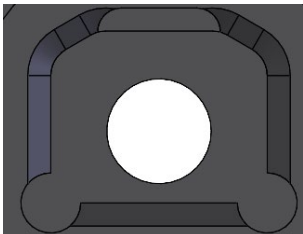
	<p>DE2590-K Adapter, MTP Dual Key</p>
	<p>DE2591 Adapter, MTP/APC Mounting Insert</p>
	<p>DE2591-AP Adapter, MTP/APC All Purpose</p>
	<p>DE2591-16 Adapter, MTP-16/APC Mounting Insert</p>
	<p>DE2591-K Adapter, MTP/APC Dual Key</p>

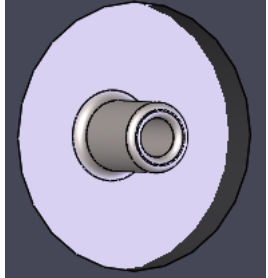

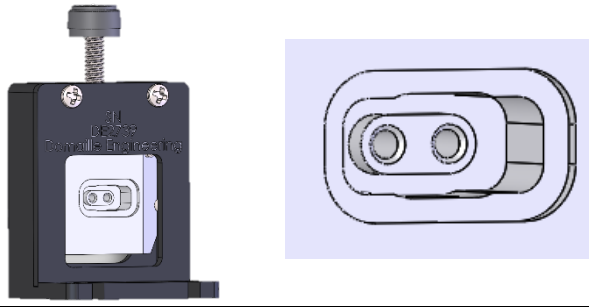
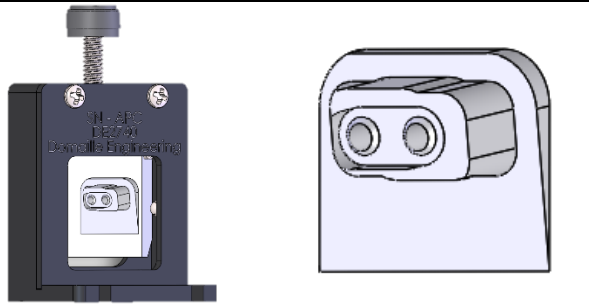
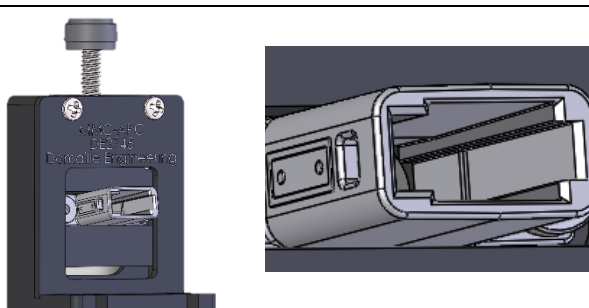
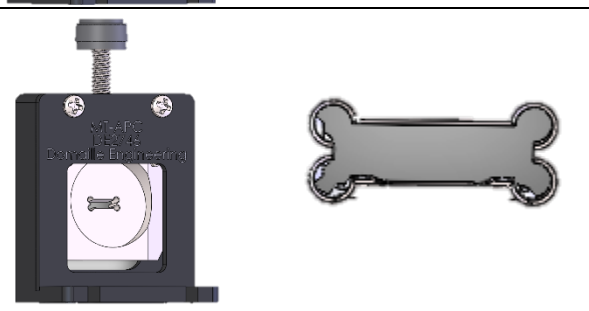

 	<p>DE2592 Adapter, MPX Angle</p>
 	<p>DE2593 Adapter, MT Ferrule Angled</p>
 	<p>DE2595 1.25 Mini Duplex W/Aperature</p>
 	<p>DE2597 MT-RJ for X-Y Stage, Composite Plastic</p>
 	<p>DE2598 Adapter, 2.0mm D-4</p>



		<p>DE2712 Adapter, 2.99mm</p>
		<p>DE2726 Adapter, AFBR Duplex</p>
		<p>DE2728 Adapter, R2F Ferrule Male</p>
		<p>DE2729 Adapter, R2F Ferrule Female</p>
		<p>DE2731 Adapter, MXC Plug W/PMT Ferrule</p>

	<p>DE2739 Adapter, SN</p>
	<p>DE2740 Adapter, 8° SN</p>
	<p>DE2743 Adapter, TMT/APC Ferrule W/Ball Plunger</p>
	<p>DE2745 Adapter, MMC/APC Connector</p>
	<p>DE2746 Adapter, SN/MT APC Ferrule W/Ball Plunger</p>

	<p>DE2747 Adapter, SN/MT APC Connector</p>
	<p>DE2751 Adapter, MMC JR/APC Connector</p>
	<p>DE28156 Bare fiber Chuck 80 -200 um, Includes DE2436</p>
	<p>DE28158 Bare fiber Chuck 125 um -250 um, Includes DE2436</p>
	<p>DE28160 Bare fiber Chuck 300 um - 1 MM, Includes DE2436</p>

Inserts for DE8800 Series

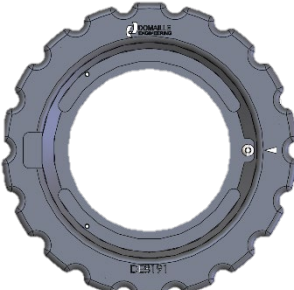
Image	Part Number Description
	<p>DE8121 Standard 12-Position Insert for Seikoh Giken 510 and Domaille</p>
	<p>DE8134 Multi-Position Insert, Fixture Scallop Orientation</p>
	<p>DE8180 Adapter plate for Domaille Cam-Lock fixture</p>
	<p>DE8182 12 Position MT for Domaille MT-EZ</p>

	<p>DE8184 Adapter Plate, DCL Max</p>
	<p>DE8185 Adapter Plate, Fiber Bundle</p>
	<p>DE8186 Adapter Plate, DCL 12-Port AbraSave C</p>
	<p>DE8191 Adapter Plate, MT-EZ 20 Port</p>
	<p>DE8192 Adapter Plate, PFH-ST-48</p>

	<p style="text-align: center;">DE8194 Adapter Plate, MT-EZ, MT-EZR 24 Port</p>
	<p style="text-align: center;">DE8198 Adapter Plate, DCX-SN</p>
	<p style="text-align: center;">DE8199 Adapter Plate, DCX-MDCJ</p>
	<p style="text-align: center;">DE8201 Adapter Plate, MT-EZ8-12</p>

Monitors

Image	Part Number Description
	<p align="center">DE19378 12.1" LCD Monitor, Plastic Frame</p>
	<p align="center">DE19408 12.1" LCD Monitor, Metal Frame</p>
	<p align="center">DE19379-BR Bracket to Attach DE19379 (12.1" Plastic Monitor) to DE2503</p>
	<p align="center">DE19408-BR Bracket to Attach DE19378 & DE19408 (12.1" Metal Monitor) to DE2503</p>



ME-12403

HMI, 13.3", PI5 4GB, 64GB SD for
Digital Microscopes





DE19411-BR



Bracket to Attach ME-12403 (13.3"
Monitor) to Digital Microscopes

Cables & Power Supplies

Image	Part Number Description
	<p>ME-12011 BNC/BNC Cable 6ft (305mm)</p>
	<p>ME-12302 Power Cable for Camera, 20” (508mm), (DE2503)</p>
	<p>ME-12303 Power Cable for Camera, 10” (254mm), (DE2600, DE8850, DE8880)</p>
	<p>ME-12304 Power Cable for Camera, 32” (813mm), (DE3200)</p>
	<p>ME-12305 Power Cable for Camera (DE2600- D1)</p>
	<p>ME-12016 AC Power Cord for 24 VDC ADPT (US)</p>

	<p>ME-12017 AC Power Cord for 24 VDC CTRLR, EURO</p>
	<p>ME-12422 Power Cord for 12 VDC, Includes 4 adaptors (EU, CN, US, UK)</p>

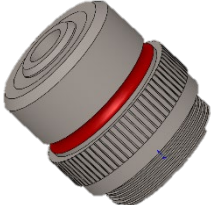
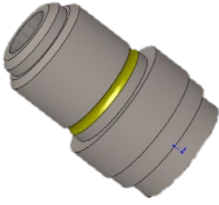
Objectives

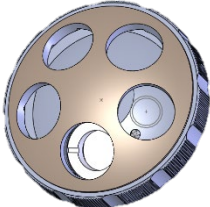
Image	Part Number Description
	<p>ME-12005 LWD 3.3X Custom Objective</p>
	<p>ME-12006 LWD 5X Objective</p>
	<p>ME-12007 LWD 10X Objective</p>
	<p>ME-12008 LWD 20X Objective</p>
	<p>ME-12009 LWD 40X Objective</p>
	<p>ME-12402 5 Hole Turret</p>

Cameras

Image	Part Number Description
	<p>ME-12360 1/2" CCD NTSC/EIA Camera, 60Hz</p>
	<p>ME-12361 1/2" CCD PAL/CCIR, 50 Hz</p>
	<p>ME-12351 USB3.1, MONO,60FPS,3.1MPIXEL, Digital, for DE2600-D1 & DE2503-D1</p>

Accessories

Image	Part Number Description
	<p>DE16073 Video Grabber Box / USB 2.0 to View Analog Images</p>
	<p>DE42001 Double Crosshair Generator</p>
	<p>ME-15305 Velmex Stage Assembly, 4 Position</p>
	<p>ME-15311 Stage Knob Assembly</p>
	<p>ME-15002 Velmex Linear Slide, 4 Position</p>
	<p>ME-12098 Deltron Focus Slide</p>

	<p>ME-12079 Fast Release Mount V Groove</p>
	<p>ME-12024 LED Blue Assembly w/Cord</p>
	<p>ME-12300 LED Controller Assembled</p>
	<p>DE35028 Light Source, Ace, EKE, 230V</p>
	<p>DE35030 Light Source, Ace, EKE, 115V</p>
	<p>DE35043 Single Chrome Gooseneck Light Guide, 18"</p>
	<p>DE35003 Dual Chrome Gooseneck Light Guide, 18"</p>

	<p>DE35004 Dual Black Bifurcated w/Spot, 23”</p>
	<p>ES1000 Eye Scope, Mini, Lighted 45X</p>
	<p>ME-15303 Bare Fiber Rotator, 250UM</p>